



Part #	Description
WFO 8100-A	18+ Jeep JL License Plate Mount

10076 Streeter Road Suite #7, Auburn, CA 95602
 Phone: 530.268.9494 www.wfoconcepts.com

WFO 8100-A

BILL OF MATERIALS		
C-31201-04	18'-22' Year V1 Camera Tab	Qty. 1
C-31201-05	22'+ Year V2 Camera Tab	Qty. 1
C-31201-10	Main Backing License Plate Mount	Qty. 1
C-31201-11	Outer Camera Mount Plate	Qty. 1
C-31201-12	Inner Camera Mount Plate	Qty. 1
33-6186	#10-32 x 3/8" SS Button Head Bolts	Qty. 4
33-9052	#2-56 x 1/4" SS Phillips Screw	Qty. 3
33-6210	1/4"-20 x 5/8" SS Button Head Bolts	Qty. 5
33-23640	1/4"-20 SS Nylock Nut w/ Wax	Qty. 1
33-3041	1/4" SS Flat Washers	Qty. 4
11-710	1/2" Plastic Body Plug	Qty. 2
TOOLS NEEDED		
1/8" & 5/32" Allen Socket 3/8" Drive Ratchet 7/16" Wrench Torx Bits: T-8, T-25, T-40 7/8" & 13mm Sockets Impact gun Small Phillips Screwdriver Pry Bar Wire crimping tools Zip Ties Anti-Seize		

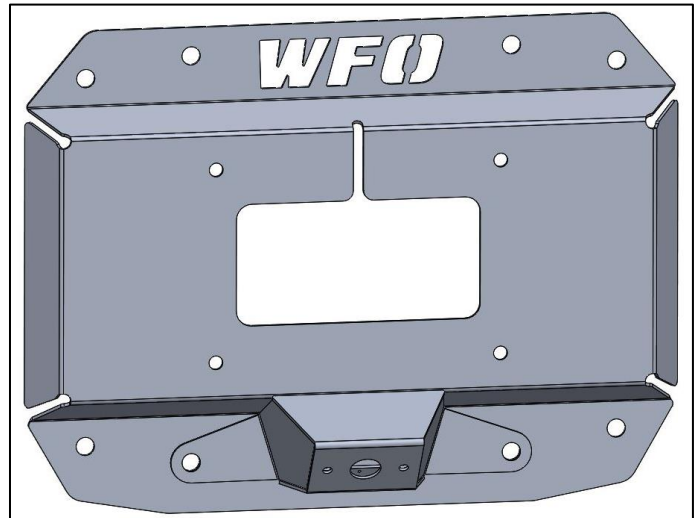

WARNING!
<p>*** Read all instructions thoroughly from start to finish before beginning the job! If these instructions are not properly followed, severe frame, suspension, tire, or body damage may result to the vehicle!</p> <p>*** WFO Concepts recommends that you exercise extreme caution when working under vehicles supported by jack stands.</p> <p>*** WFO Concepts recommends all installation to be performed by a professional shop/service technician. Product failure due to improper installation will not be covered under WFO's warranty policy.</p>

TECH NOTES:
<ul style="list-style-type: none"> - This kit replaces the spare tire mount on the tailgate. Some wires will need to be relocated and/or cut. Be sure to double check all wires before modifying. The Jeep wiring harness can be sensitive to adding accessories they weren't intended for. When possible, use the correct wire size and harnesses the signal wire came from. - Whenever installing Stainless Steel Hardware it's a good idea to use Anti Seize to preventing galling of the threads.

REMOVAL:

1. Remove outer camera cover using a T-40 Torx so you can access the lug nut that is behind this cover.
2. Remove the spare tire.
3. Open tailgate and remove the inner plastic trim by gently popping it off. Be careful not to break the plastic retainers that hold this cover to the inner part of the tailgate.
4. Unplug the top 2 smaller electrical plugs (Figure A). Then pull the two wires out through the hole just left of the vent on the outside of the tailgate (Figure B).

Fig. A



Fig. B



5. Remove stock plastic spare tire carrier. Using a 13mm socket, remove the 8 bolts on the outside perimeter of the stock plastic spare tire carrier (Figure C). **SAVE THESE BOLTS**, you will reuse them.

Fig. C



- Remove the 2 bolts, T-25, on either side of the camera mount (Figure D). This will allow you to remove the bracket from the inside of the spare tire mount. Flip over and gently pry the bracket up from the inside out. (Figure E)

Fig. D

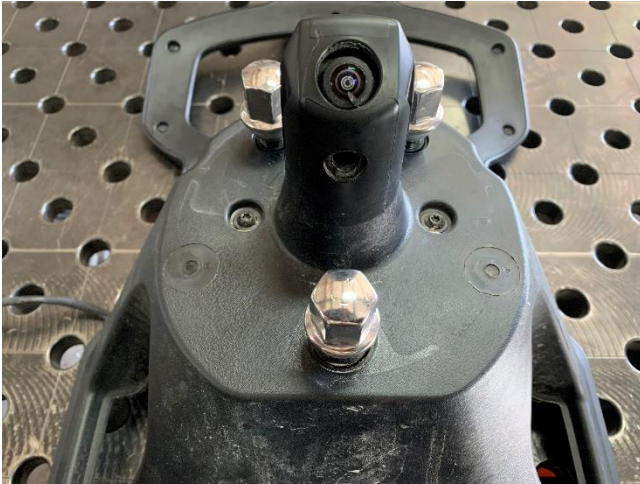

Fig. E



- To get the harness completely removed, unscrew the 3 small screws that mount the camera using a T8-bit driver (Figure F). Unclip the camera (Figure G) and slip the loom out of all the brackets. Discard tire rack and camera mount, you will not need these anymore.

Fig. F



Fig. G



- Next you will need to remove the third brake light wire harness. Using a T-25, remove the 7 bolts that surround the outside to remove the cover (Figure H-1). Once cover is removed, unplug harness from the 3rd brake light and remove from bracket. (Figure H-2)

Fig H-1

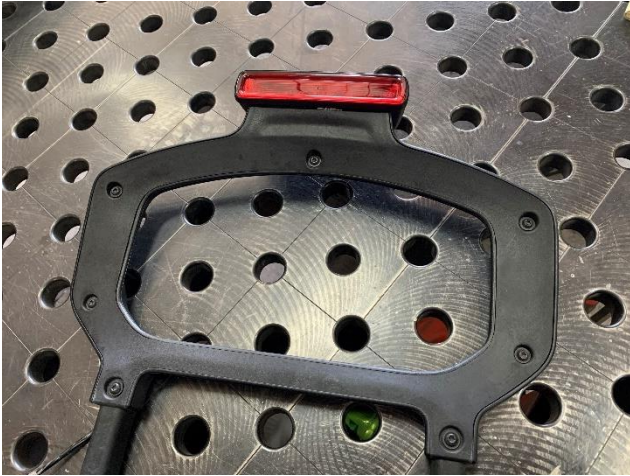

Fig H-2



INSTALL:

- Once the old tire carrier is removed, clean up any dirt or debris off of the tailgate. Fig. I

Fig. I



- Take your new WFO license plate mount and insert 6 of the 8 bolts you removed from the tire carrier and loosely bolt the plate into your tailgate. Leaving the lower 2 middle bolts out.

11. Route the reverse camera wires out through the vent and down through the square at the bottom of the mount. Fig. J

Fig. J



12. Find the remaining camera mount pieces. First determine if you have the older 2018-2022, 3-bolt style camera or the newer 2022+ non bolt in camera. If you have the 3-bolt style look at Fig. K-1 and K-2 for assembly.

Fig. K-1

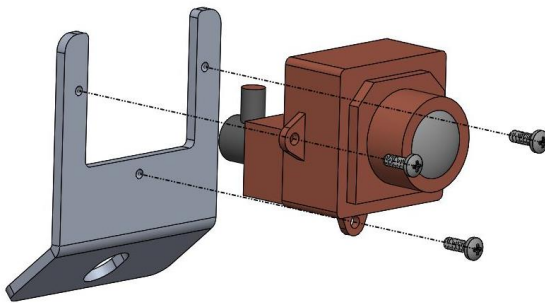
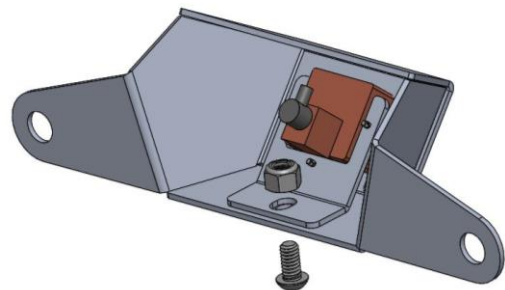
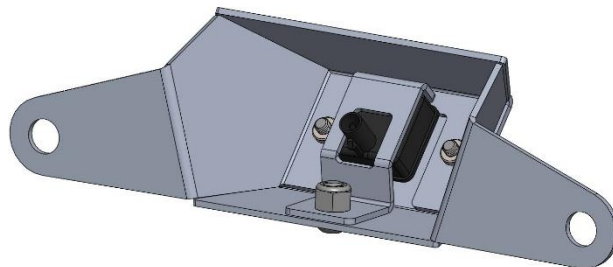

Fig. K-2



13. For the later non bolt in style refer to Fig. L. It simply just clam shells the camera into place.

Fig. L



14. Take either assembled camera mount back to the jeep. Plug in your wire and use the remaining 2 bolts to bolt on the camera mount. Fig. M-1 and M-2

Fig. M-1

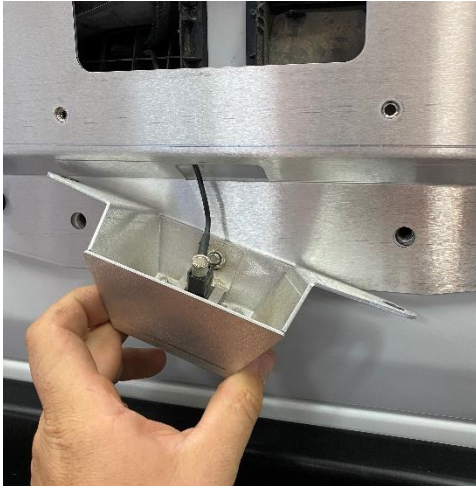

Fig. M-2



15. If you purchased our 3rd brake light kit, follow the instructions that come with them to identify the correct colors. You will use the previously removed 3rd brake light wire harness that you re routed through the vent with the camera wire. You will need to snip the connector off to use these wires.
16. For the license plate lights the preferred way is to source the signal wire from the original license plate mount on the bumper. You will need to add a wire that runs back down with the factory loom inside the tailgate, through the canvas sheath, back behind the passenger rear panel, and either down along the weather stripping or out and under the tub near the bumper, then into the driver rear taillight area, to tap into the factory harness. Find the original harness that went to your license plate light. Using a test light, confirm the correct signal wire, snip it, and connect it to the previously ran wire.
17. Using the remaining qty. (4) ¼" SS Allen bolts and washers, bolt your license plate to the main plate using the threaded holes.
18. Finalize up any wire ties, panels, and bolts. Test your running lights as well as the brake lights to make sure everything works properly. Lastly, included with your hardware are 2 plugs. These are to replace your factory spare tire bumpers for an even cleaner look if you want. The picture below shows the 2 plugs installed.





10076 Streeter Road Suite #7, Auburn, CA 95602
Phone: 530.268.9494 www.wfoconcepts.com

Follow us on all Social Media Platforms!

Remember to share your photos and tag #WFOCONCEPTS to be featured on our page!

